

Miniatur Radial Gebläse
Miniature Radial Blower
Ventilateur miniature radial

SN EN ISO 9001 CERTIFICATED

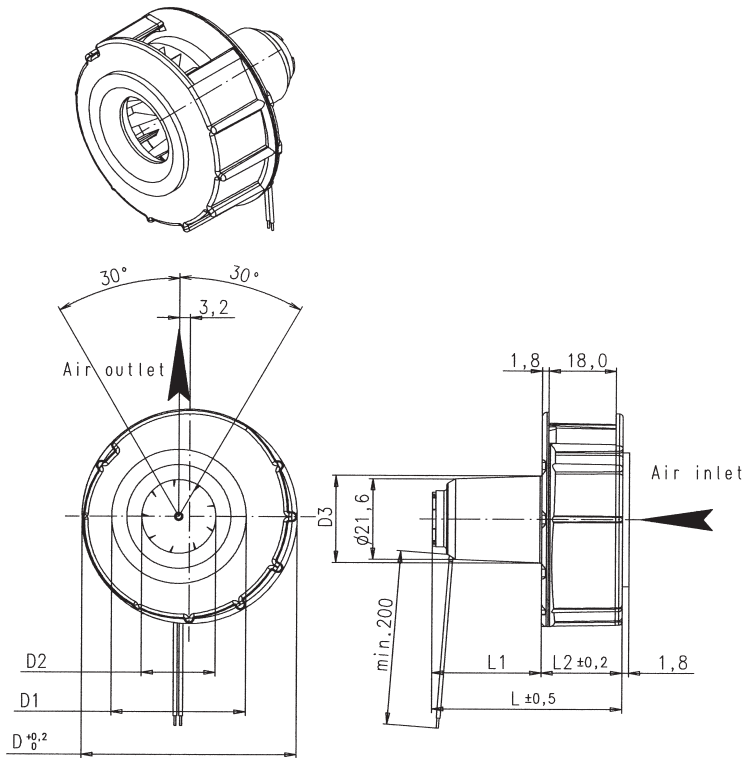

U64HM-003GK-2 3 V DC

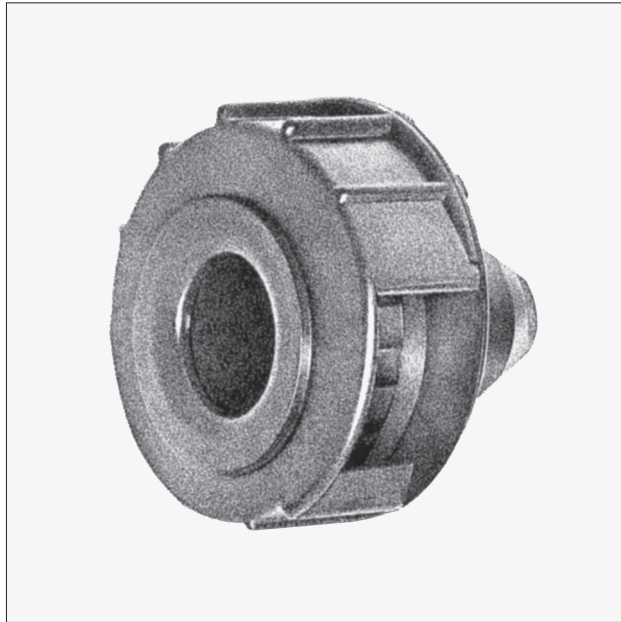
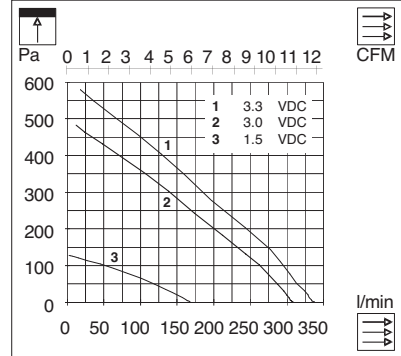

U64HM-006GK-2 6 V DC

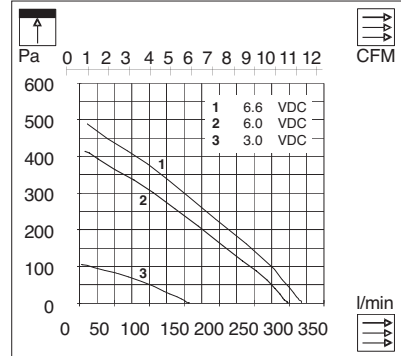



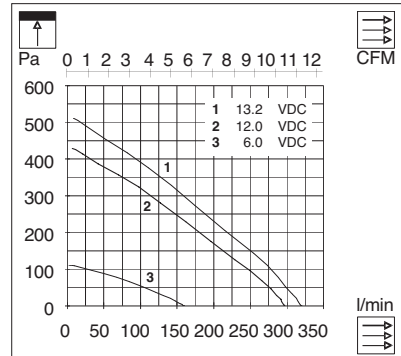

























U64HM-012GK-2 12 V DC



U64HM	mm	inch
D	ø 64	ø 2.520
D1	ø 40	ø 1.575
D2	ø 22	ø 0.866
D3	ø 26	ø 1.024
L	56.5	2.224
L1	32.5	1.279
L2	24	0.945

Technische Daten
Technical data
Caractéristiques techniques

			U64HM-003GK-2	U64HM-006GK-2	U64HM-012GK-2
	U_N	V	3	6	12
	U	V	1.5 - 3.3	3 - 6.6	6 - 13.2
	I_N	mA	1080	420	218
	I_N	mA	840	320	165
	I_N	mA	440	155	94
	I_{block}	A	5.5	1.6	2.7
	P_N	W	2.52	1.92	1.98
	n	min ⁻¹	10'300	9650	9800
	n	min ⁻¹	11'200	10'250	10'450
	n	min ⁻¹	12'500	11'300	11'500
	\dot{V}	l/min; CFM	305/10.77	295/10.41	295/10.41
	\dot{V}	l/min; CFM	152/5.37	145/5.12	146/5.15
	p	Pa	278	250	253
	p	Pa	485	415	425
	LpA	dB(A)	56	55	55
	MTTF	hr	2000	2500	2500
	T	°C/F	-20...+65/-5...+150F	-20...+65/-5...+150F	-20...+65/-5...+150F
	m	gr/oz.	80/2.82	80/2.82	80/2.82
	Lead Length	mm/inch		200/7.87 (AWG 24)	
	Housing Material		PPO UL-94V-1	PPO UL-94V-1	PPO UL-94V-1
	Sleeve Bearing		●	●	●
	Ball Bearing		-	-	-
	Tacho Signal		-	-	-
	Inlet Adapter		-	-	-
	Outlet Adapter		-	-	-
	Explosion Protection		-	-	-
	Freiblasend		Free blowing	Refoulement libre	
	Prüfbarbeitspunkt bei ca. 50% Luftmenge		Inspection working point at approx. 50% air vol.	Point de travail de contrôle appr. à 50% volume d'air	
	Druckerhöhung statisch		Pressure difference static	Différence de pression statique	

Specifications are subject to change without notice. Specifications on this Datasheet are for reference.